

TOP

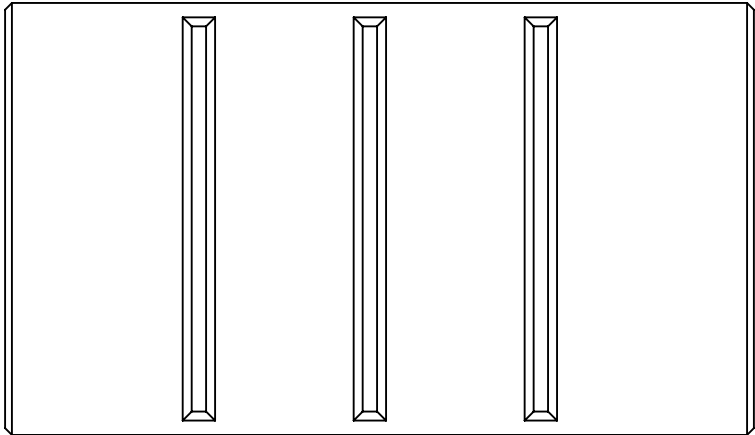

LEFT SIDE

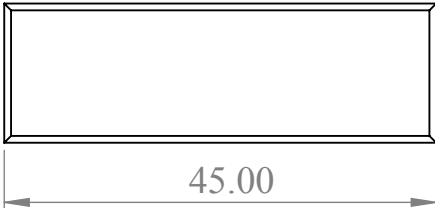

FRONT

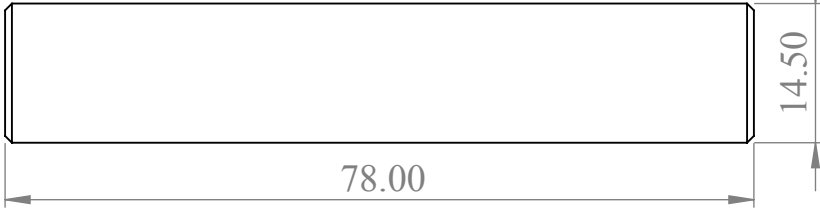

RIGHT SIDE

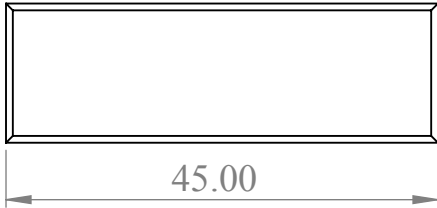

ALL DIMENSIONS ARE IN INCHES
UNLESS OTHERWISE SPECIFIED.

PROPRIETARY AND CONFIDENTIAL
THE INFORMATION CONTAINED IN THIS
DRAWING IS THE SOLE PROPERTY OF
BLAZE PLASTICS PARTNERSHIP. ANY
REPRODUCTION IN PART OR AS A WHOLE
WITHOUT THE WRITTEN PERMISSION OF
BLAZE PLASTICS PARTNERSHIP IS
PROHIBITED.

BLAZE PLASTICS PARTNERSHIP

LP 185

SCALE: 1:20

Date

SHEET 1 OF 1